

Quick Start Guide

ProFace X (SL)

Version: 1.0

1 Overview

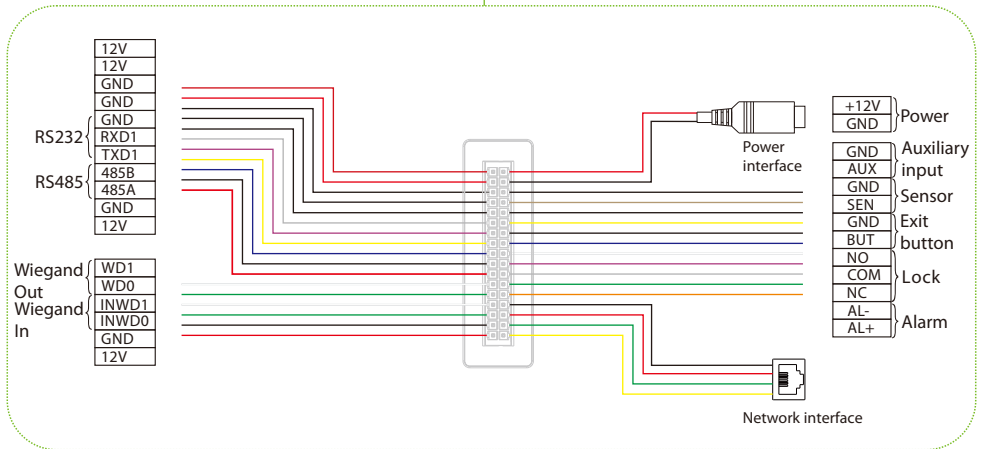
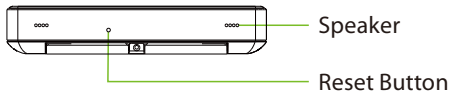
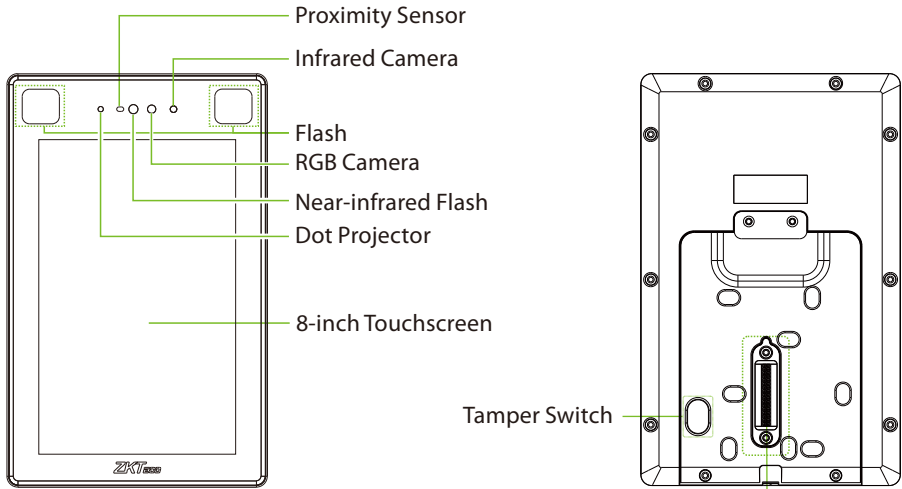

2 Installation Environment

Please refer to the following recommendations for installation.



KEEP DISTANCE



AVOID GLASS REFRACTION



AVOID DIRECT SUNLIGHT AND EXPOSURE

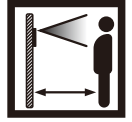

KEEP EFFECTIVE DISTANCE
0.3-2.5m

3 Device Installation

❖ Install on the wall

- ① Attach the mounting template sticker to the wall, and drill holes according to the mounting paper.
- ② Fix the backplate on the wall using wall mounting screws.
- ③ Attach the device to the backplate.
- ④ Fasten the device to the backplate with a security screw.

①

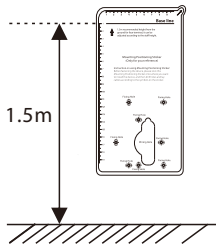

②

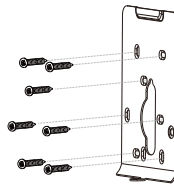

③

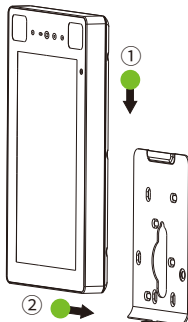

④

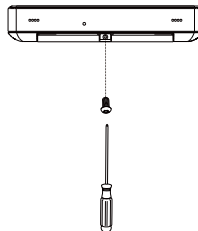

3 Device Installation

❖ Install on the barrier gate

Please thread the wire through the bracket before installation.

- ① Drill a hole on the barrier gate, insert the bracket into the hole and fix it with a nut.
- ② Adjust the angle of the device.

①

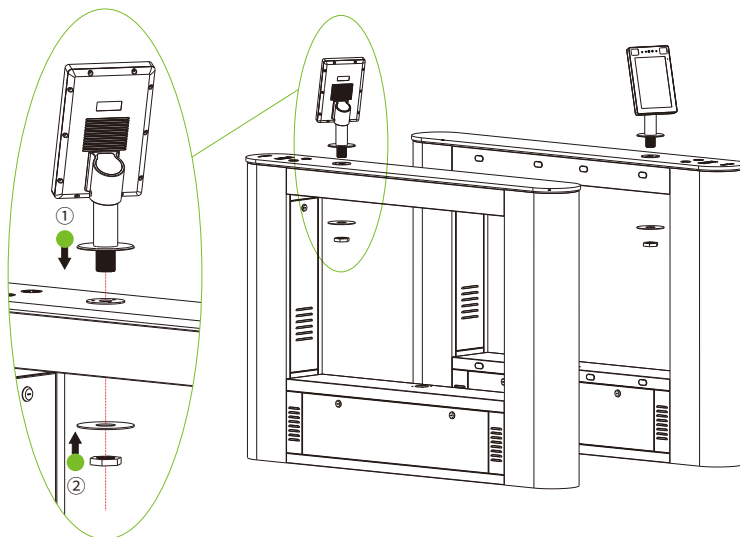

②

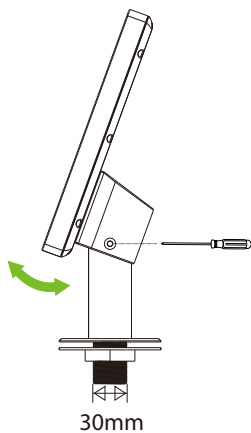

4 Standalone Installation

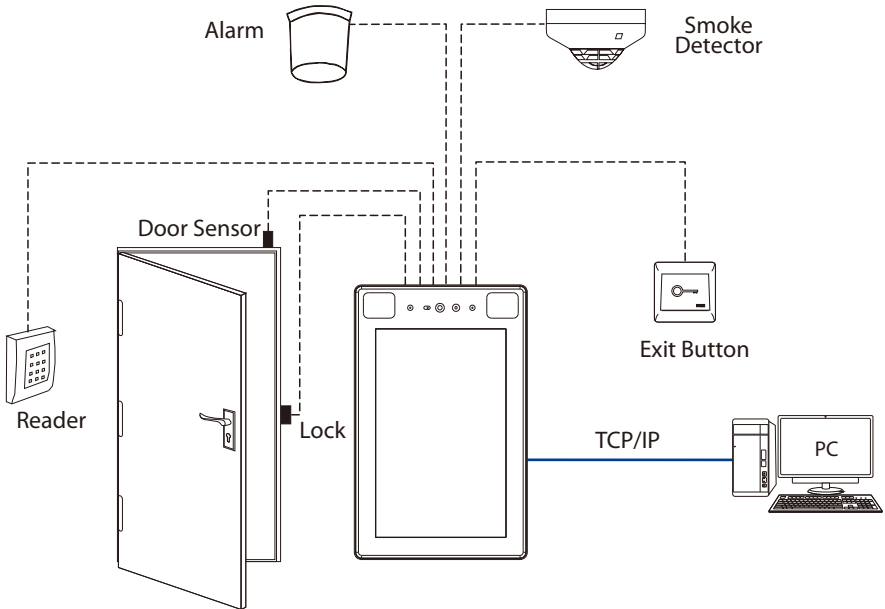

5 Door Sensor, Exit Button & Alarm Connection

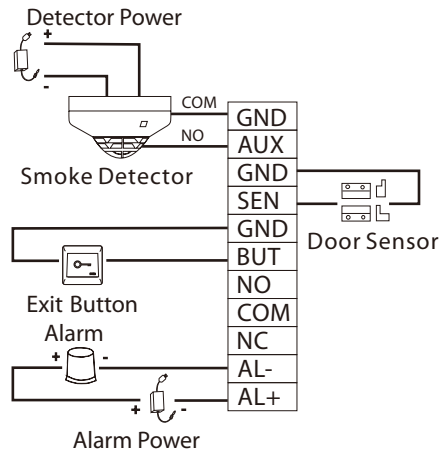
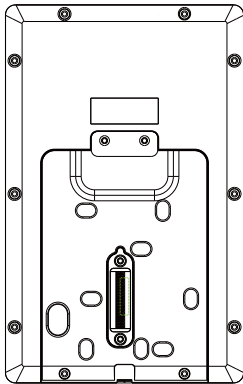

6 Lock Relay Connection

The system supports **Normally Opened Lock** and **Normally Closed Lock**.

The **NO LOCK** (normally unlocked when power-on) is connected with 'NO' and 'COM' terminals, and the **NC LOCK** (normally locked when power-on) is connected with 'NC' and 'COM' terminals.

Take NC Lock as an example below:

1) Device not sharing power with the lock

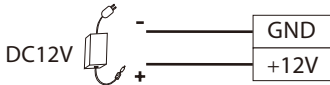

Maximum 30V 3A input.

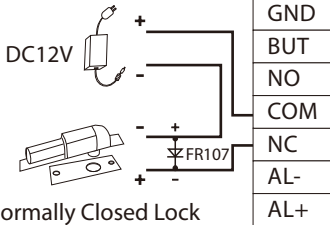

Do not reverse the polarity.

2) Device sharing power with the lock

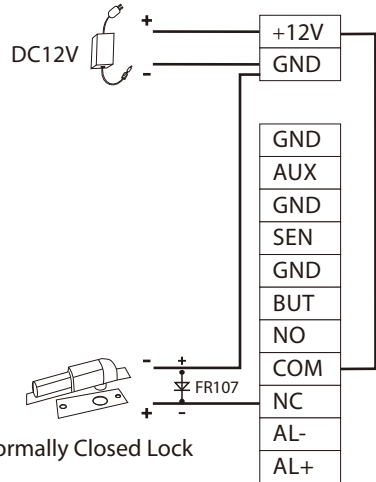

7 Wiegand Reader Connection

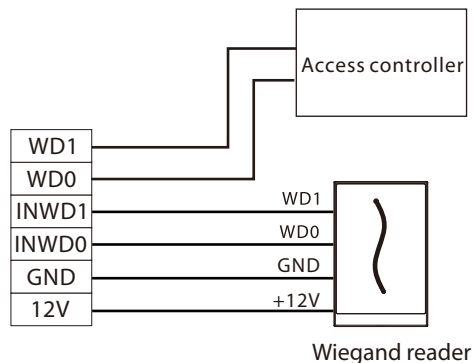
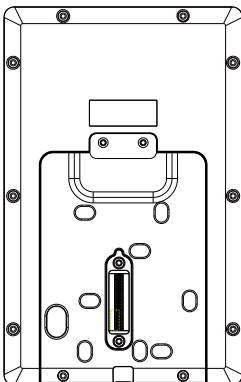

8 Barrier Connection

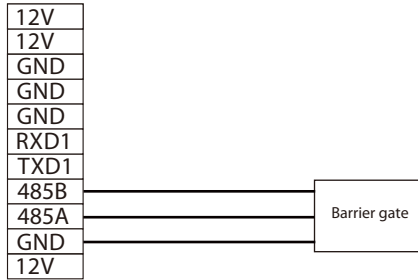
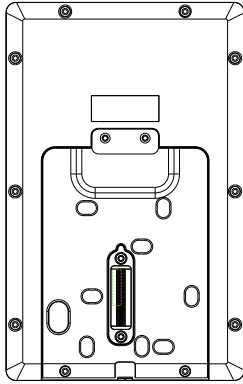

9 RS485 Connection

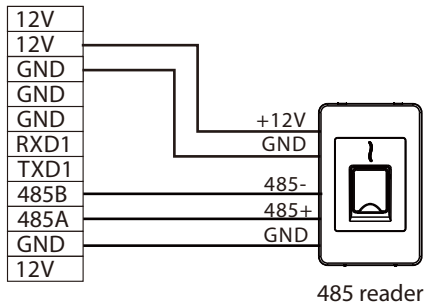
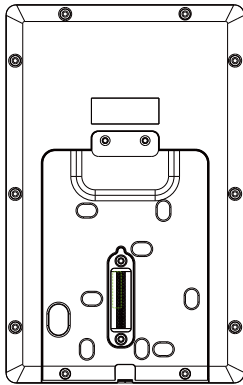

Note: 485A and 485B can be connected to the Barrier gate or the 485 Reader, separately, but cannot be connected to the gate and reader at the same time.

10 Power Connection

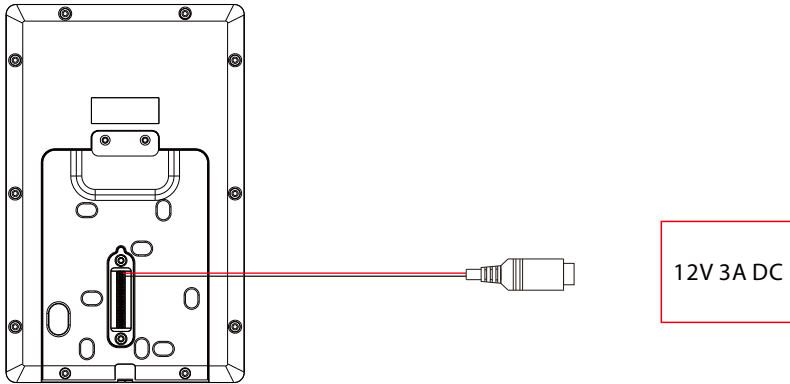

- Recommended power supply: 12V - 3A
- To share the power with other devices, use a power supply with higher current ratings.

11 Ethernet Connection

Connect the device and computer software over an Ethernet cable. An example is shown below:

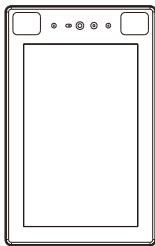

Default IP address: 192.168.1.201
Subnet mask: 255.255.255.0



IP address: 192.168.1.130
Subnet mask: 255.255.255.0

Note: In LAN, IP addresses of the server (PC) and the device must be in the same network segment when connecting to ZKBioSecurity software.

Click on [Comm.] > [Ethernet] > [IP Address], input the IP address and click on [OK].

12 User Registration

When there is no super administrator set in the device, click on  to enter the menu. After setting the super administrator, the system will request for the administrator's verification before entering the menu. For the security purpose, it is recommended to register a super administrator at the first time you use the device.

Method1: Register on the device

Click on  > [User Mgt.] > [New User] to register a new user. Settings include entering user ID and name, face, password and profile photo, setting user role and access control role.

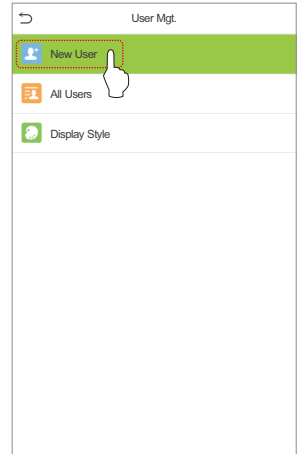
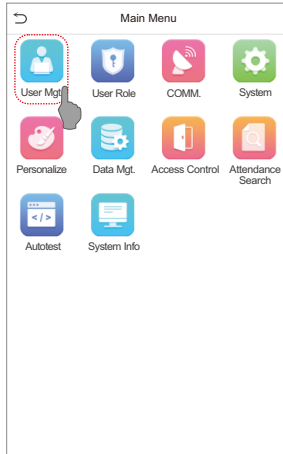

New User	
User ID	3
Name	Mike
User Role	Normal User
Face	1
Password	*****
Profile Photo	1
Access Control Role	



Method2: Register on ZKBioSecurity software

Please set the IP address and cloud service server address in the Comm. Menu option on the device.

1. Click **[Access]** > **[Access Device]** > **[Device]** > **[Search Device]** to search the device on the software. When an appropriate server address and port is set on the device, the searched devices are displayed automatically.

The screenshot displays the 'Search Device' window in the ZKBioSecurity software. The window title is 'Search Device'. At the top, there is a search bar with a magnifying glass icon and a 'Search' button. Below the search bar, a progress bar shows 'Total Progress' at 100%. A table lists the search results with columns for IP Address, MAC Address, Subnet Mask, Gateway Address, Serial Number, Device Type, Set Server, and Operations. The first row shows IP Address 192.168.0.31, MAC Address 255.255.255.0, Subnet Mask 192.168.0.1, Serial Number XXXXX000000000, and Device Type S*****. The second row shows IP Address 192.168.10.214, MAC Address 255.255.255.0, Subnet Mask 192.168.1.1, Serial Number XXXXX000000000, and Device Type ProFace X [SL]. The 'Operations' column for the second row has an 'Add' button. A dialog box titled 'Add' is open in the foreground, with fields for Device Name (192.168.4.18), Icon Type (Door), Area (Area Name), and Add to Level (-----). There is a checkbox for 'Clear Data in the Device when Adding' which is unchecked. A warning message at the bottom of the dialog box states: '[Clear Data in the Device when Adding] will delete data in the device (except event record), please use with caution!'. The dialog box has 'OK' and 'Cancel' buttons at the bottom.

Step 1 Search Device

Step 2 Search

Step 3 Add

Step 4 Add

2. Click **[Add]** in operation column, a new window will pop-up. Select Icon type, Area, and Add to Level from each dropdowns and click **[OK]** to add the device.
3. Click **[Personnel]** > **[Person]** > **[New]** and fill in all the required fields to register a new users in the software.
4. Click **[Access]** > **[Device]** > **[Device Control]** > **[Synchronize All Data to Devices]** to synchronize all the data to the device including the new users.

For more details, please refer to the **ZKBioSecurity User Manual**.

Method 3: Register on the phone

Once ZKBioSecurity software installed, users could enroll face via browser application on their own mobile phone.

1. Click **[Personnel]** > **[Parameters]**, input "http://Server address: Port" in the QR Code UGL bar. The software will automatically generate a QR code. Scan the QR code or login onto "http://Server address: Port/app/v1/adreg" by the mobile phone to register users.

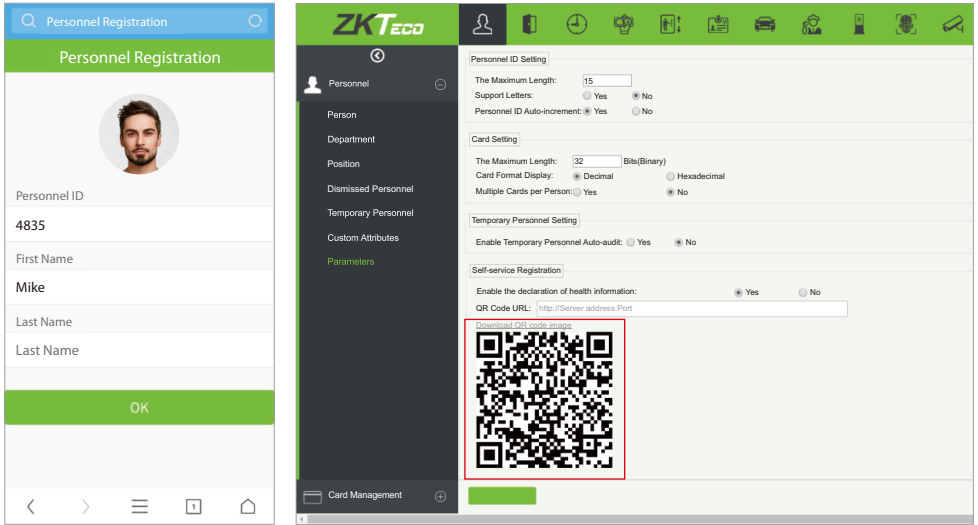

2. The users will be displayed in **[Personnel]** > **[Temporary Personnel]**, click **[Review]**.

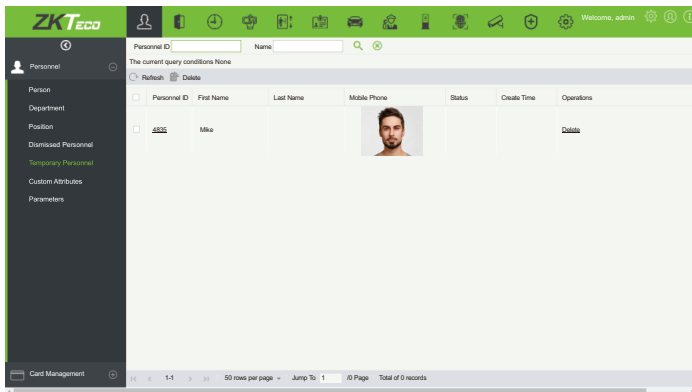



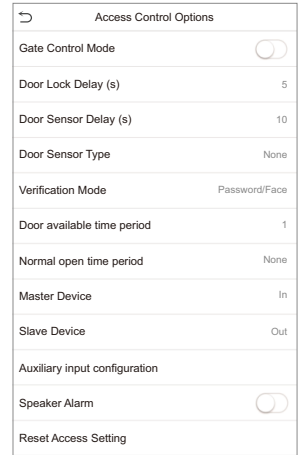
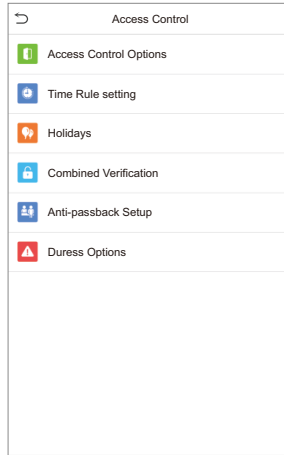
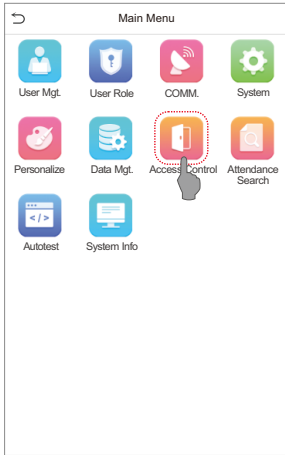

13 Access Control Settings

Click on  > **[Access Control]** to enter the access control management interface and set relevant parameters of access control.



14 Ethernet and Cloud Server Settings

Click on  > **[Comm.]** > **[Ethernet]** to set the network parameters. If the TCP/IP communication of the device is successful, the icon  will be displayed in the upper right corner of the standby interface. Click on  > **[Comm.]** > **[Cloud Server Setting]** to set the server address and server port, that is, the IP address and port number of the server after the software is installed. If the device communicates with the server successfully, the icon  will be displayed in the upper right corner of the standby interface.

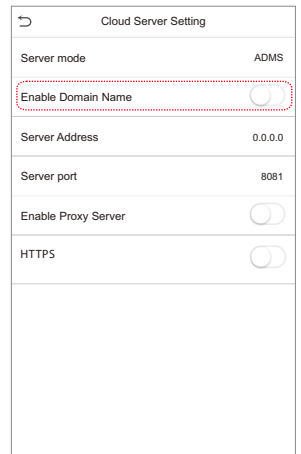
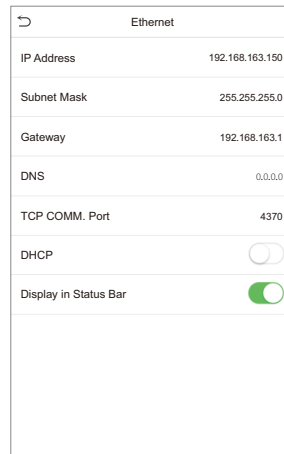
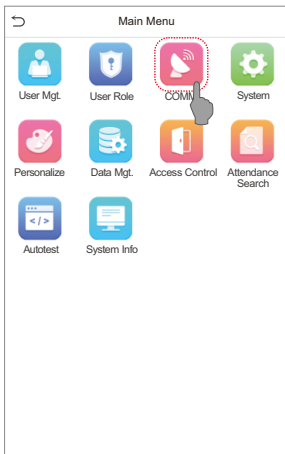

ZKTeco Industrial Park, No. 32, Industrial Road,

Tangxia Town, Dongguan, China.

Phone : +86 769 - 82109991

Fax : +86 755 - 89602394

www.zkteco.com

